



McIntosh Laboratory, Inc. 2 Chambers Street Binghamton, New York 13903-2699 Phone: 607-723-3512 www.mcintoshlabs.com

MC611
Quad Balanced
Power Amplifier
Owner's Manual





Important Safety Information is supplied in a separate document “Important Additional Operation Information Guide”

Thank You

Your decision to own this McIntosh MC611 Quad Balanced Power Amplifier ranks you at the very top among discriminating music listeners. You now have “The Best.” The McIntosh dedication to “Quality,” is assurance that you will receive many years of musical enjoyment from this unit.

Please take a short time to read the information in this manual. We want you to be as familiar as possible with all the features and functions of your new McIntosh.

Please Take A Moment

The serial number, purchase date and McIntosh Dealer name are important to you for possible insurance claim or future service. The spaces below have been provided for you to record that information:

Serial Number: _____

Purchase Date: _____

Dealer Name: _____

Technical Assistance

If at any time you have questions about your McIntosh product, contact your McIntosh Dealer who is familiar with your McIntosh equipment and any other brands that may be part of your system. If you or your Dealer wish additional help concerning a suspected problem, you can receive technical assistance for all McIntosh products at:

McIntosh Laboratory, Inc.
2 Chambers Street
Binghamton, New York 13903
Phone: 607-723-3512
Fax: 607-724-0549

Customer Service

If it is determined that your McIntosh product is in need of repair, you can return it to your Dealer. You can also return it to the McIntosh Laboratory Service Department. For assistance on factory repair return procedure, contact the McIntosh Service Department at:

McIntosh Laboratory, Inc.
2 Chambers Street
Binghamton, New York 13903
Phone: 607-723-3515
Fax: 607-723-1917

Table of Contents

Safety Instructions	2
(Separate Sheet)	Important Additional Operation Information Guide
Thank You and Please Take a Moment.....	2
Technical Assistance and Customer Service	2
Table of Contents	2
General Information	2
Connector and Cable Information	3
Introduction.....	3
Performance Features	3
Dimensions	5
Installation	6
Rear Panel Connections and Switch	7
Output Terminals and How to Connect	8-9
Output Terminals and How to Connect for Bi-Amp	10-11
Front Panel Displays and Controls.....	12
How to Operate.....	13
Technical Description	14-17
Specifications.....	18
Packing Instruction.....	19

General Information

1. For additional connection information, refer to the owner’s manual(s) for any component(s) connected to the MC611.
2. The MC611 mutes the speaker output for approximately two seconds when first turned on.
3. For the best performance and safety it is important to always match the impedance of the Loudspeaker to the Power Amplifier connections. Refer to “How to Connect” pages 7 thru 10.

Note: The impedance of a Loudspeaker actually varies as the Loudspeaker reproduces different frequencies. As a result, the nominal impedance rating of the Loudspeaker (usually measured at a midrange frequency) might not always agree with the impedance of the Loudspeaker at low frequencies where the greatest amount of power is required. Contact the Loudspeaker Manufacturer for additional information about the actual impedance of the Loudspeaker before connecting it to the McIntosh MC611.

4. In the event the MC611 over heats, due to improper ventilation and/or high ambient temperature, the protection circuits will activate. The Front Panel Power Guard LED will continuously indicate ON and the audio will be muted. When the MC611 has returned to a safe operating temperature, normal operation will resume.
5. When discarding the unit, comply with local rules or regulations. Batteries should never be thrown away or incinerated but disposed of in accordance with the local regulations concerning battery disposal.
6. For additional information on the MC611 and other McIntosh Products please visit the McIntosh Website at www.mcintoshlabs.com.



Connector and Cable Information

XLR Connectors

Below is the Pin configuration for the XLR Balanced Input, Input/Output Connectors on the MC611. Refer to the diagram for connection:

- PIN 1: Shield/Ground
- PIN 2: + Input/Output
- PIN 3: - Input/Output

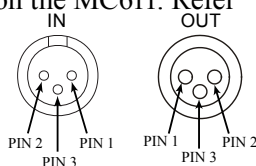

Power Control Connector

The MC611 Power Control Input receives an On/Off signal from +5 to +12 volts. The Power Control Output will in turn provide a +12 volt Output Signal with a total current up to 50mA. An additional connection is for controlling the illumination of the MC611 Power Output Meters. The 1/8 inch stereo mini phone plug connects to a McIntosh Preamplifier or A/V Control Center Power Control Output.

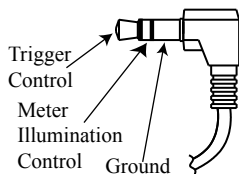

Output Terminal Connector

When cables with spade lugs are used for Loudspeaker Connection, the spade lugs need an opening of at least 3/10 inch (7.6mm).

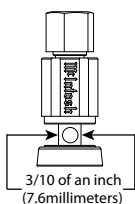

Introduction

Now you can take advantage of traditional McIntosh standards of excellence in the MC611 Quad Balanced Power Amplifier. The 600 watts high current output will drive any high quality Loudspeaker. The MC611 reproduction is sonically transparent and absolutely accurate. The McIntosh Sound is “The Sound of the Music Itself”.

Performance Features

• Power Output

The MC611 is a Power Amplifier with a capability of 600 watts into 2, 4 or 8 ohm speakers with less than 0.005% distortion. The Power Amplifier Circuitry uses Thermal Trak¹ Output Transistors for lower distortion and cool operation.

• Quad Balanced Circuitry

The MC611 is fully balanced from input to output. It consists of two matched power amplifiers operating in push-pull with their outputs combined in a McIntosh Autoformer. The Quad Balanced configuration cancels virtually all distortion.

• Patented Autoformer

McIntosh designed and manufactured Output Autoformers provide an ideal match between the amplifier output stages and speaker loads of 2, 4 and 8 ohms. The Autoformers also provide perfect DC protection for your valuable loudspeakers.

• Balanced and Unbalanced Inputs

Balanced connections guard against induced noise and allow long cable runs without compromising sound quality.

• Power Guard

The patented McIntosh Power Guard circuit prevents the amplifier from being over driven into clipping, with its harsh distorted sound that can also damage your valuable loudspeaker.

• Sentry Monitor and Thermal Protection

McIntosh Sentry Monitor power output stage protection circuits ensure the MC611 will have a long and

trouble free operating life. Built-in Thermal Protection Circuits guard against overheating.

• Special Power Supply

A very large Power Transformer and Large Capacitors ensure stable noise free operation even though the power line varies.

• Illuminated Power Meter

The Illuminated Power Output Watt Meter on the MC611 is peak responding, and indicates the true power output of the amplifier. The Peak Watt Hold Mode allows the meter to temporarily stay at the highest power output and then slowly decay. The Front Panel Meter Illumination may be switched Off at any time.

• McIntosh Custom Binding Posts

McIntosh patent pending gold plated output terminals deliver high current output. They accept large diameter wire and spade lugs. Banana plugs may also be used only in the United States and Canada.

• Fiber Optic Solid State Front Panel Illumination

The even Illumination of the Front Panel is accomplished by extra long life Light Emitting Diodes (LEDs).

• Glass Front Panel and Super Mirror Chassis Finish

The famous McIntosh Illuminated Glass Front Panel and the Stainless Steel Chassis with Super Mirror Finish ensures the pristine beauty of the MC611 will be retained for many years.

¹ ThermalTrak™ and ON Semiconductor are trademarks of Semiconductor Components Industries, LLC



Dimensions

The following dimensions can assist in determining the best location for your MC611.

Front View of the MC611

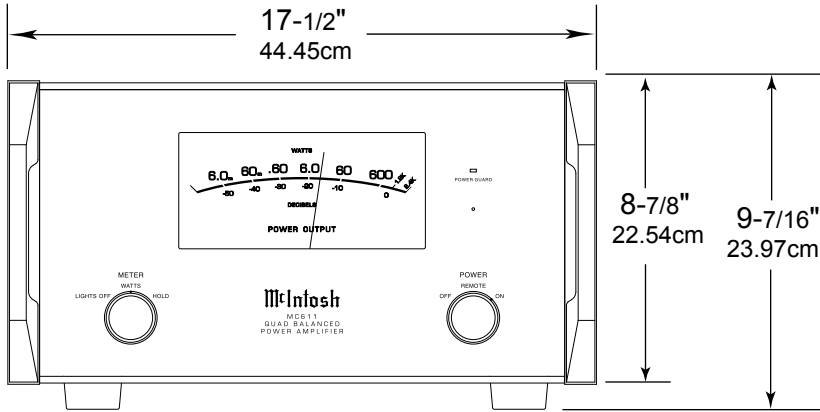

Rear View of the MC611

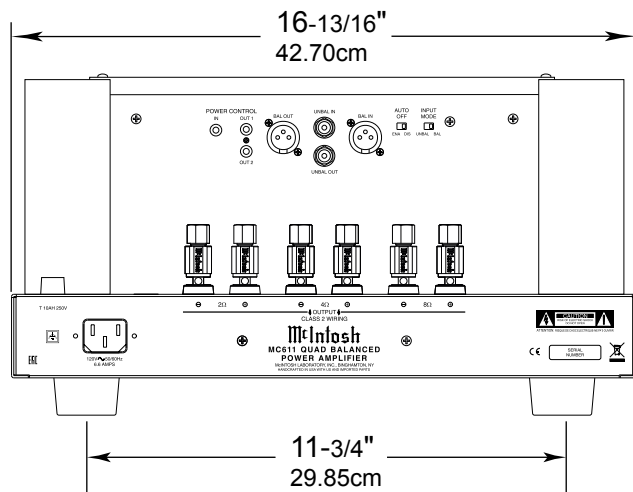

Side View of the MC611

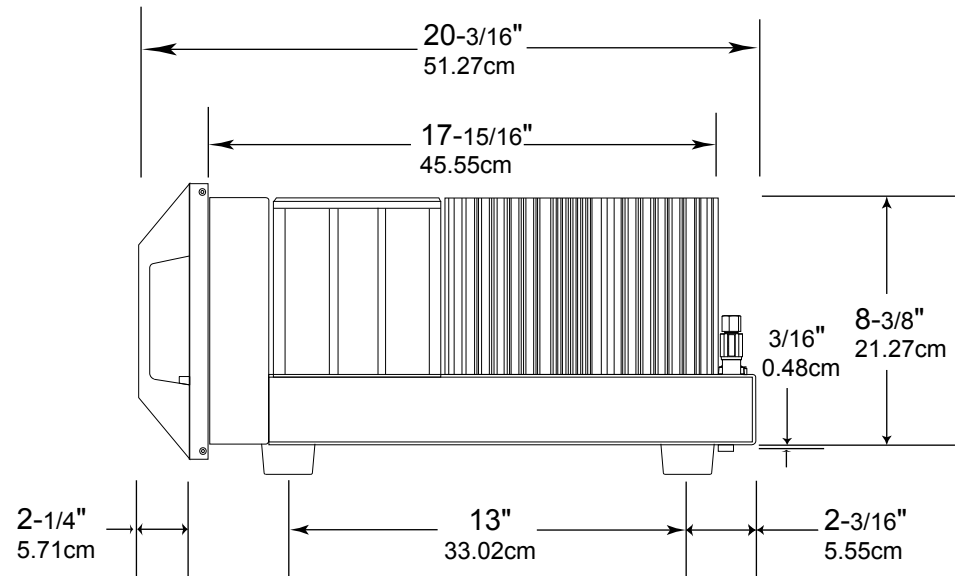

Installation

The MC611 can be placed upright on a table or shelf, standing on its four feet. It also can be custom installed in a piece of furniture or cabinet of your choice. The four feet may be removed from the bottom of the MC611 when it is custom installed as outlined below. The four feet together with the mounting screws should be retained for possible future use if the MC611 is removed from the custom installation and used free standing. The required panel cutout, ventilation cutout and unit dimensions are shown.

Always provide adequate ventilation for your MC611. Cool operation ensures the longest possible operating life for any electronic instrument. Do not install the MC611 directly above a heat generating component such as a high powered amplifier. If all the components are installed in a single cabinet, a quiet running ventilation fan can be a definite asset in maintaining all the system components at the coolest possible operating temperature.

A custom cabinet installation should provide the following minimum spacing dimensions for cool operation.

Allow at least 6 inches (15.24cm) above the top, 2 inches (5.08cm) below the bottom, 3 inches (7.62cm) behind the rear panel and 2 inches (5.08cm) on each side of the Power Amplifier, so that airflow is not obstructed. Allow 2-1/2 inches (6.35 cm) in front of the mounting¹ panel for clearance. **Be sure to cut out a ventilation hole in the mounting shelf according to the dimensions in the drawing.**

¹ When the MC611 is installed together with other McIntosh Components, check clearances on all components before proceeding.

MC611 Front Panel
Custom Cabinet Cutout

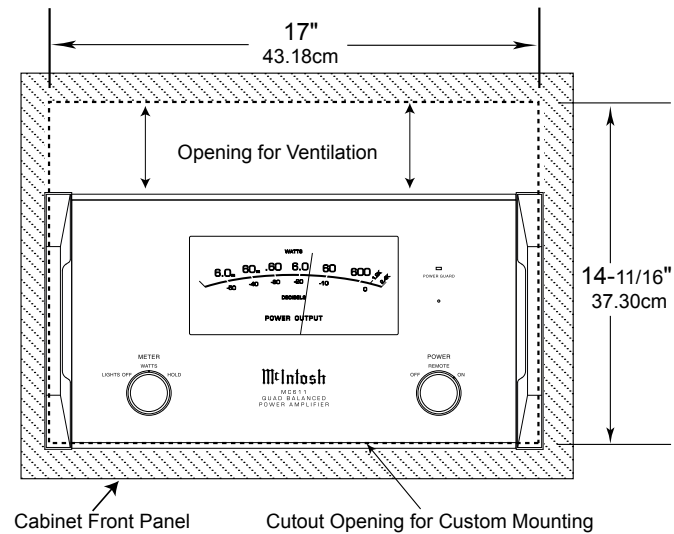

MC611 Side View
in Custom Cabinet

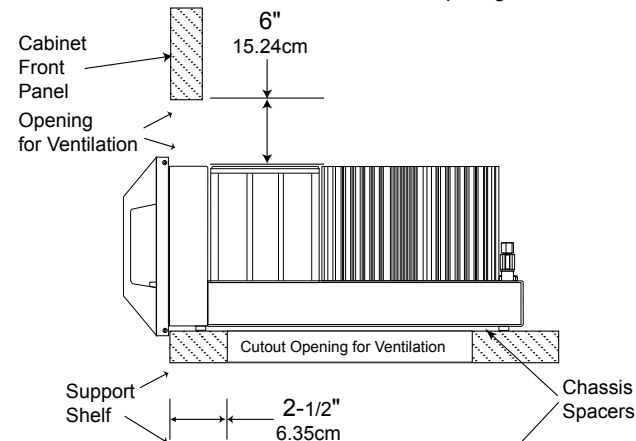

MC611 Bottom View
in Custom Cabinet

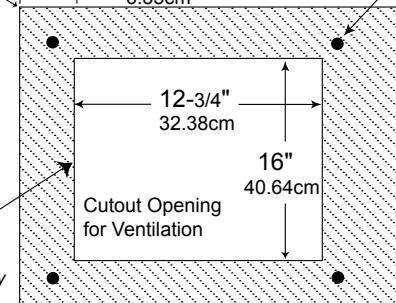

Note: Center the cutout horizontally on the unit. For purposes of clarity, the above illustration is not drawn to scale.



Rear Panel Connections and Switch

POWER CONTROL IN receives turn On/Off signals from a McIntosh component

BALANCED OUTPUT for an audio cable to the next Power Amplifier Input

UNBALANCED INPUT for an audio cable from a Preamplifier or A/V Processor audio output

BALANCED INPUT for audio cables from a Preamplifier or A/V Processor audio output

INPUT MODE switch selects between UNBALANCED or BALANCED Input

AUTO OFF Mode Switch selects between ENABLED or DISABLED

POWER CONTROL OUT 1 and 2 send turn On/Off signals to the next McIntosh Component

Fuse holder, refer to information on the rear panel of your MC611 to determine the correct fuse size and rating

UNBALANCED OUTPUT for an audio cable to the next Power Amplifier Input

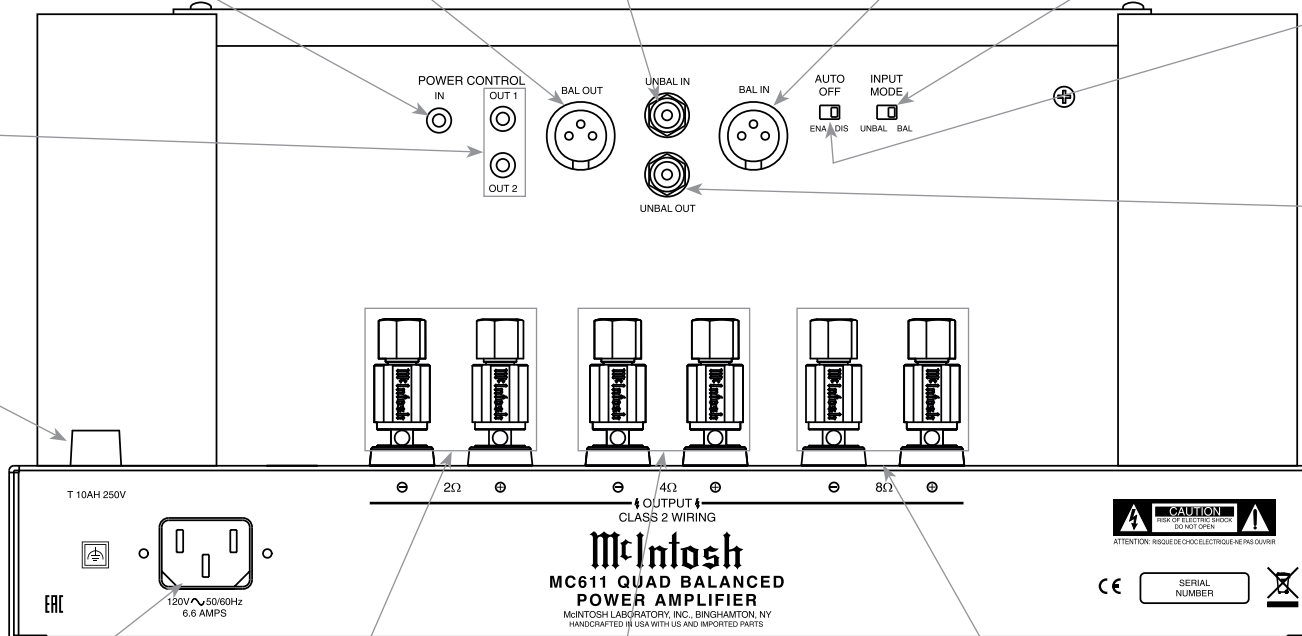

OUTPUT Connections for a 2 ohm Loudspeaker

OUTPUT Connections for an 8 ohm Loudspeaker

Connect the MC611 power cord to a live AC outlet. Refer to the rear panel to determine the correct voltage

OUTPUT Connections for a 4 ohm Loudspeaker

Caution: The Loudspeaker ⊖ Negative Connections are above chassis ground. Do not combine any connections together, ground them or connect with another MC611.

Output Terminals

When connecting the Loudspeaker Hookup Cables to the MC611 Power Amplifier Output Terminals please follow the steps below:

1. Rotate the top of the Output Terminal Post counterclockwise until an opening appears. Refer to figures A and B.
2. Insert the Loudspeaker hookup cable into the Output Terminal Post opening or the cable spade lug around the center post of the Output Terminal. Refer to figure C.
3. Rotate the top of the Output Terminal Post clockwise until it is finger tight. Refer to figure D.
4. Place the supplied McIntosh Wrench over the top of the Output Terminal and rotate it one quarter of a turn (90°) to secure the Loudspeaker Cable Connection. **Do not over tighten.** Refer to figure E.

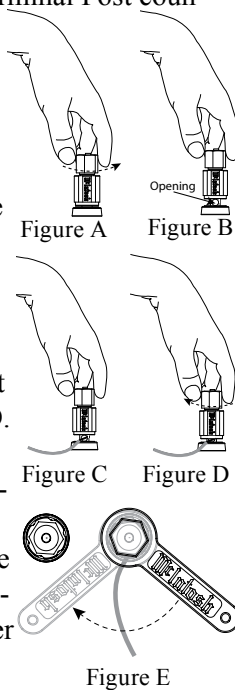

How to Connect

Caution: Do not connect the AC Power Cord to the MC611 Rear Panel until after the Loudspeaker Connections are made and the protective Terminal Connections Cover is installed. Failure to observe this could result in Electric Shock.

The connection instructions below, together with the MC611 Connection Diagram located on the separate folded sheet “Mc1A”, is an example of a typical audio system. Your system may vary from this, however the actual components would be connected in a similar manner. For additional information refer to “Connector and Cable Information” on page 3.

1. For Remote Power Control, connect a power control cable from the Audio Preamplifier or A/V Control Center Power Control Output 1 to the Amplifier POWER CONTROL IN.
2. Connect XLR cables from the Balanced Output 1 Right Channel, (refer to note 2 below) of an Audio Preamplifier or A/V Processor to the Amplifier BALANCED INPUT. Place the INPUT MODE Switch in the BALANCED Position.

Notes: 1. An optional hookup is to use an unbalanced cable and place the INPUT MODE Switch in the UNBALANCED Position.
2. When multiple MC611s are used in a Stereo or Multichannel System, match up the Preamplifier or A/V Processor Channel Output designation to each MC611 with Loudspeaker and the Loudspeaker location in the room.

3. Using a suitable tool remove the two screws from the MC611 Rear Panel and temporarily place them in a safe place. Refer to figure 1.

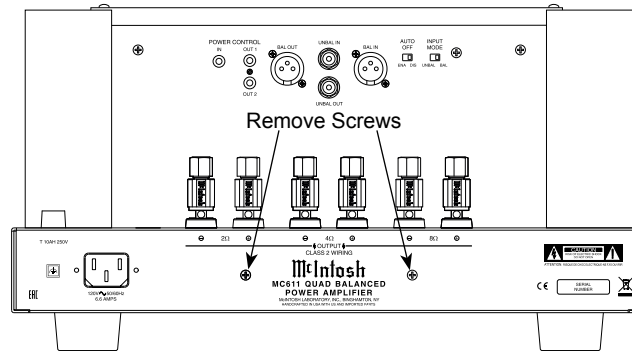

Figure 1

This McIntosh MC611 Quad Balanced Power Amplifier is designed for Loudspeakers with an impedance of 2 ohms, 4 ohms or 8 ohms. Connect a single Loudspeaker only to the Output Terminals.

When connecting Loudspeakers to the MC611 it is very important to use cables of adequate size, so there is little to no power loss in the cables. The size is specified in Gauge Numbers or AWG (American Wire Gauge). The smaller the Gauge number, the larger the wire size:

Loudspeaker Cable Distance vs Wire Gauge Guide			
Loudspeaker Impedance	25 feet (7.62 meters) or less	50 feet (15.24 meters) or less	100 feet (30.48 meters) or less
2 Ohms	12AWG	10AWG	8AWG
4 Ohms	14AWG	12AWG	10AWG
8 Ohms	16AWG	14AWG	12AWG

4. Prepare the Loudspeaker Hookup Cable for attachment to the MC611 Power Amplifier:

Bare wire cable ends:

Carefully remove sufficient insulation from the cable ends, refer to figures 2, 3 & 4. If the cable is stranded, carefully twist the strands together as tightly as possible.

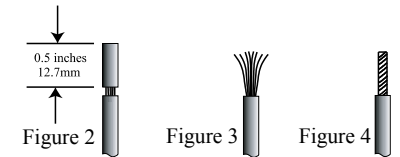

Notes: 1. If desired, the twisted ends can be tinned with solder to keep the strands together.
2. The prepared bare wire cable ends may be inserted into spade lug connectors.
3. Banana plugs are for use in the United States and Canada only.

Banana Plugs are for use in the United States and Canada only:

5. Locate the Terminal Connections Cover from the inside of the MC611 shipping carton. Insert the just prepared Loudspeaker hookup cables thru the

cover opening on the left side. Refer to figure 5.

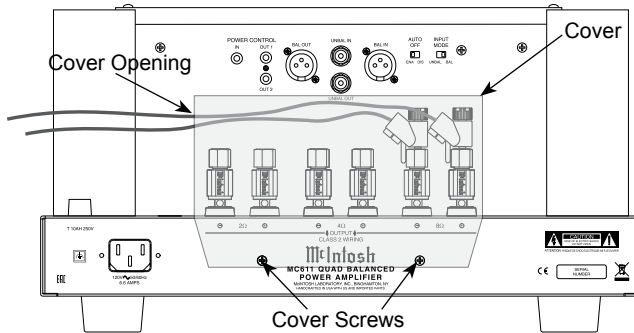

Figure 5 (Inside USA and Canada)

6. Attach the previously prepared bare wire cable ends into the banana plugs and secure the connections. Refer to figure F.

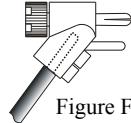

Figure F

7. Rotate the top of the Output Terminal Post clockwise until it is finger tight. Refer to figure G. Then using the McIntosh Wrench, rotate the top of the Output Terminal one quarter of a turn (90°). **Do not over tighten.** Refer to figure E.

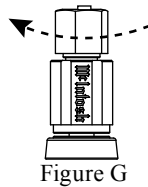

Figure G

8. Referring to figure H, connect the Loudspeaker hookup cables with banana plugs into the hole at the top of the MC611 Negative and Positive Output Terminals. The terminals are identified as 2Ω (ohms), 4Ω (ohms) or 8Ω (ohms) connection to match the impedance of the Loudspeaker, being careful to observe the correct polarities.

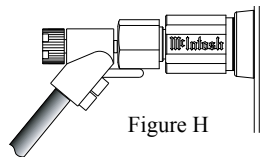

Figure H

Note: The illustration in figure 5 is connections for 8Ω (ohms) Loudspeakers.

If the Loudspeaker's impedance is in-between the available connections, use the nearest lower imped-

ance connection. Refer to "General Information" Note 3 on page 2 for additional information.

WARNING: Loudspeaker terminals are hazardous live and present a risk of electric shock. For additional instruction on making Loudspeaker Connections contact your McIntosh Dealer or McIntosh Technical Support.

- Attach the Terminal Connections Cover to the MC611 Rear Panel with the previously removed Screws. Refer to figure 5.
- Connect the MC611 power cord to an active AC outlet.

Spade Lug or Wire Connections:

- Locate the Terminal Connections Cover from the inside of the MC611 shipping carton. Insert the just prepared Loudspeaker hookup cables thru the cover opening on the right side. Refer to figure 6.
- Connect the Loudspeaker hookup cables to the MC611 Negative Output Terminal and Positive Output Terminal identified as 2Ω (ohms), 4Ω (ohms) or 8Ω (ohms) connection to match the impedance of the Loudspeaker, being careful to observe the correct polarities. Insert the spade lug connector or prepared section of the cable end into the terminal side access hole, and tighten the terminal cap until the cable is firmly clamped into the terminals so the lugs or wire cannot slip out. Refer to figures 7 and 8.

Note: The illustration in figure 6 is connections for 8Ω (ohms) Loudspeakers.

If the Loudspeaker's impedance is in-between the available connections, use the nearest lower impedance connection. Refer to "General Information" Note 3 on page 2 for additional information.

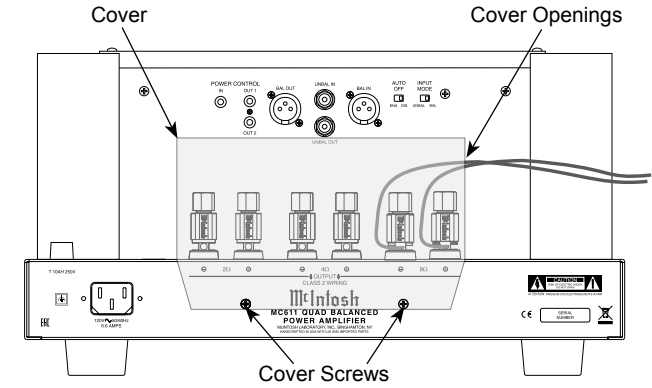

Figure 6 (Outside USA and Canada)

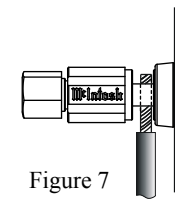

Figure 7

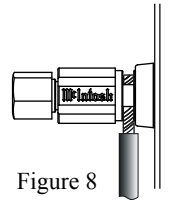

Figure 8

WARNING: Loudspeaker terminals are hazardous live and present a risk of electric shock. For additional instruction on making Loudspeaker Connections contact your McIntosh Dealer or McIntosh Technical Support.

- Attach the Terminal Connections Cover to the MC611 Rear Panel with the previously removed Screws. Refer to figure 6.
- Connect the MC611 power cord to an active AC outlet.

Output Terminals

When connecting the Loudspeaker Hookup Cables to the MC611 Power Amplifier Output Terminals please follow the steps below:

1. Rotate the top of the Output Terminal Post counterclockwise until an opening appears. Refer to figures A and B.
2. Insert the Loudspeaker hookup cable into the Output Terminal Post opening or the cable spade lug around the center post of the Output Terminal. Refer to figure C.
3. Rotate the top of the Output Terminal Post clockwise until it is finger tight. Refer to figure D.
4. Place the supplied McIntosh Wrench over the top of the Output Terminal and rotate it one quarter of a turn (90°) to secure the Loudspeaker Cable Connection. **Do not over tighten.** Refer to figure E.

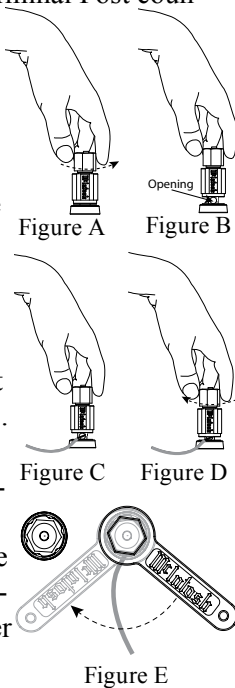

1. For Remote Power Control, connect a power control cable from the Audio Preamplifier or A/V Processor Power Control Trig 1 Output to Amplifier One POWER CONTROL IN.
2. Connect a power control cable from Amplifier One Power Control OUTput 1 to Amplifier Two POWER CONTROL IN.
3. Connect XLR cables from the Balanced Output 1 Right Channel (refer to note 2 below) of an Audio Preamplifier or A/V Processor to Amplifier BALanced INput. Place the INPUT MODE Switch in the BALanced Position.

Notes: 1. An optional hookup is to use an unbalanced cable and place the INPUT MODE Switch in the UNBALanced Position.
2. When multiple MC611s are used in a Stereo or Multichannel System, match up the Preamplifier or A/V Processor Channel Output designation to each MC611 with Loudspeaker and the Loudspeaker location in the room.

4. Connect XLR cables from Amplifier One Audio BALanced OUTput to Amplifier Two BALanced INput.
5. Using a suitable tool remove the two screws from the MC611 Rear Panel and temporarily place them in a safe place. Refer to figure 1.

This McIntosh MC611 Quad Balanced Power Amplifier is designed for Loudspeakers with an impedance of 2 ohms, 4 ohms or 8 ohms. Connect a single Loudspeaker only to the Output Terminals.

When connecting Loudspeakers to the MC611 it is very important to use cables of adequate size, so there is little to no power loss in the cables. The size is specified in Gauge Numbers or AWG (American Wire Gauge). The smaller the Gauge number, the larger the wire size:

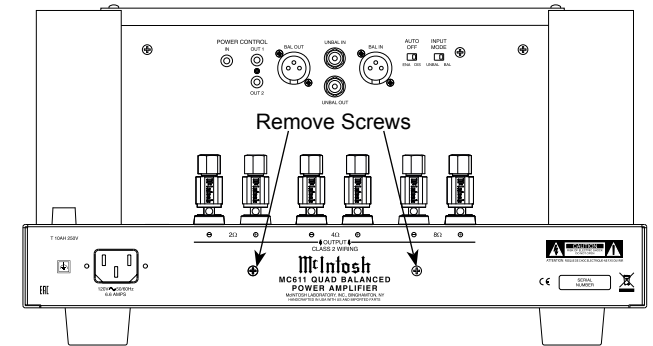

Figure 1

Loudspeaker Cable Distance vs Wire Gauge Guide

Loudspeaker Impedance	25 feet (7.62 meters) or less	50 feet (15.24 meters) or less	100 feet (30.48 meters) or less
2 Ohms	12AWG	10AWG	8AWG
4 Ohms	14AWG	12AWG	10AWG
8 Ohms	16AWG	14AWG	12AWG

6. Prepare the Loudspeaker Hookup Cable for attachment to the MC611 Power Amplifier:

Bare wire cable ends:

Carefully remove sufficient insulation from the cable ends, refer to figures 2, 3 & 4. If the cable is stranded, carefully twist the strands together as tightly as possible.

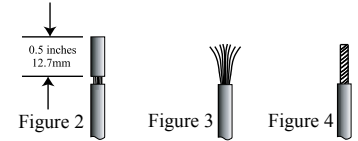

- Notes:* 1. If desired, the twisted ends can be tinned with solder to keep the strands together.
2. The prepared bare wire cable ends may be inserted into spade lug connectors.
3. Banana plugs are for use in the United States and Canada only.

How to Connect for Bi-Amp

Caution: Do not connect the AC Power Cord to the MC611 Rear Panel until after the Loudspeaker Connections are made and the protective Terminal Connections Cover is installed. Failure to observe this could result in Electric Shock.

The connection instructions below, together with the MC611 Connection Diagram located on the separate folded sheet “Mc1B”, is an example of a typical audio system. Your system may vary from this, however the actual components would be connected in a similar manner. For additional information refer to “Connector and Cable Information” on page 3.

Banana Plugs are for use in the United States and Canada only:

7. Locate the Terminal Connections Cover from the inside of the MC611 shipping carton. Insert the just prepared Loudspeaker hookup cables thru the cover opening on the right side. Refer to figure 5.

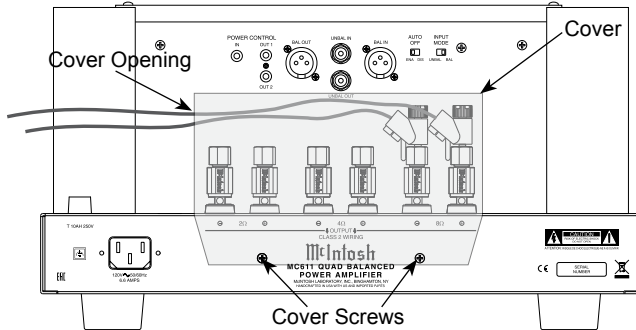

Figure 5 (Inside USA and Canada)

8. Attach the previously prepared bare wire cable ends into the banana plugs and secure the connections. Refer to figure F.

9. Rotate the top of the Output Terminal Post clockwise until it is finger tight. Refer to figure G. Then using the McIntosh Wrench, rotate the top of the Output Terminal one quarter of a turn (90°). **Do not over tighten.** Refer to figure E.

10. Referring to figure H, connect the Loudspeaker hookup cables with banana plugs into the hole at the top of the MC611 Negative and Positive Output Terminals. The terminals are identified

as 2Ω (ohms), 4Ω (ohms) or 8Ω (ohms) connection to match the impedance of the Loudspeaker, being

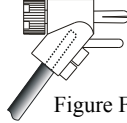

Figure F

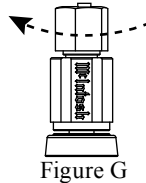

Figure G

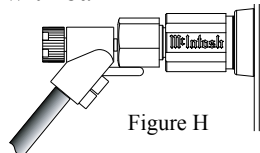

Figure H

careful to observe the correct polarities.

Note: The illustration in figure 5 is connections for 8Ω (ohms) Loudspeakers.

If the Loudspeaker's impedance is in-between the available connections, use the nearest lower impedance connection. Refer to "General Information" Note 3 on page 2 for additional information.

WARNING: Loudspeaker terminals are hazardous live and present a risk of electric shock. For additional instruction on making Loudspeaker Connections contact your McIntosh Dealer or McIntosh Technical Support.

11. Attach the Terminal Connections Cover to the MC611 Rear Panel with the previously removed Screws. Refer to figure 5.
12. Connect the MC611 power cord to an active AC outlet.

Spade Lug or Wire Connections:

13. Locate the Terminal Connections Cover from the inside of the MC611 shipping carton. Insert the just prepared Loudspeaker hookup cables thru the cover opening on the right side. Refer to figure 6.
14. Connect the Loudspeaker hookup cables to the MC611 Negative Output Terminal and Positive Output Terminal identified as 2Ω (ohms), 4Ω (ohms) or 8Ω (ohms) connection to match the impedance of the Loudspeaker, being careful to observe the correct polarities. Insert the spade lug connector or prepared section of the cable end into the terminal side access hole, and tighten the terminal cap until the cable is firmly clamped into the terminals so the lugs or wire cannot slip out. Refer to figures 7 and 8.

Note: The illustration in figure 6 is connections for 8Ω (ohms) Loudspeakers.

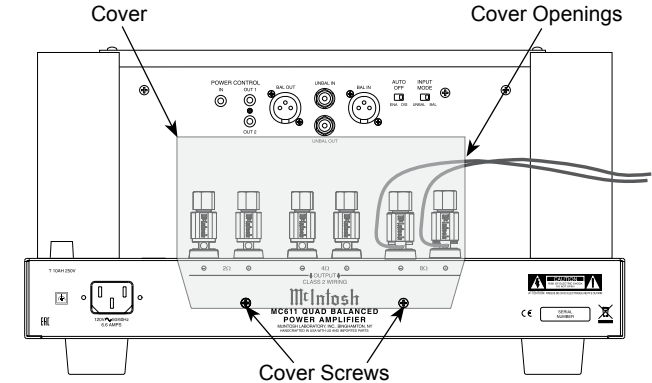

Figure 6 (Outside USA and Canada)

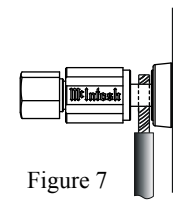

Figure 7

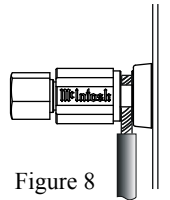
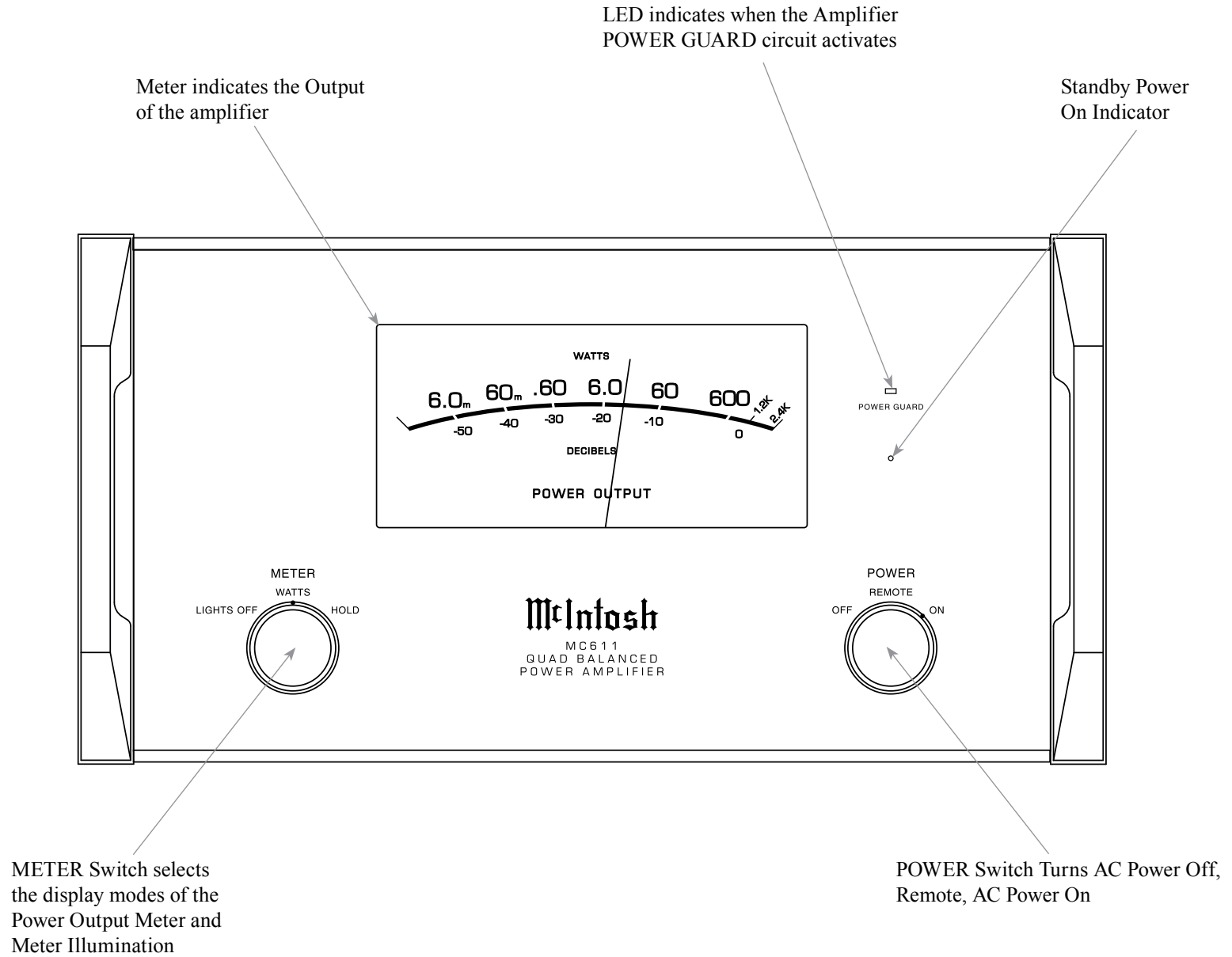

Figure 8

If the Loudspeaker's impedance is in-between the available connections, use the nearest lower impedance connection. Refer to "General Information" Note 4 on page 2 for additional information.

WARNING: Loudspeaker terminals are hazardous live and present a risk of electric shock. For additional instruction on making Loudspeaker Connections contact your McIntosh Dealer or McIntosh Technical Support.

15. Attach the Terminal Connections Cover to the MC611 Rear Panel with the previously removed Screws. Refer to figure 6.
16. Connect the MC611 power cord to an active AC outlet.



How to Operate

Power On

To have the MC611 automatically turn On or Off when a control center turns on or off, rotate the power switch to the Remote position. For manual operation, rotate the power switch to the On or Off position as desired. Refer to figure 8.

Note: There must be a power control connection between the MC611 and the Audio Preamplifier or A/V Control Center, in order for the remote power turn-on to function.

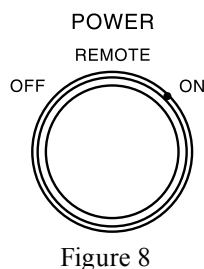

Figure 8

Meter Selection

Rotate the meter mode switch to select the meter operation mode you desire. Refer to figures 9 and 10.

Lights Off - Meter

illumination is switched Off and the meter will continue to indicate the power output.

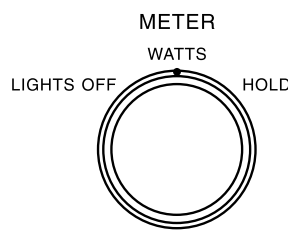

Figure 9

Note: When Power Control Input of the MC611 is connected to an Audio Preamplifier or A/V Control Center with Remote Meter Illumination Control, the Meter Illumination will automatically be remotely controlled (On/Off) with the METER Switch set to the WATTS or HOLD position.

Watts- The meter responds to all the musical information being produced by the am-

plifier. It indicates to an accuracy of at least 95% of the power output with only a single cycle of a 2000Hz tone burst.

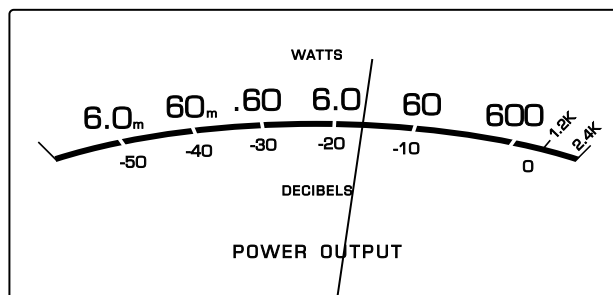

Figure 10

Hold - The meter pointer is locked to the highest power peak in a sequence of peaks. It is electronically held to this power level until a higher power peak passes through the amplifier. The meter pointer will then rise to the newer higher indication. If no further power peaks are reached, the meter pointer will very slowly return to its rest position or lower power level. The decay rate is approximately 6dB per minute.

Note: The MC611 Power Output Meter indicates the actual power delivered to the loudspeakers by responding to the combination of current and voltage output.

Input Mode Switch

The Input Mode Switch, which is located on the Rear Panel of the MC611, allows selection of either the Balanced or Unbalanced Input. Refer to figure 11.

INPUT
MODE



UNBAL BAL

Figure 11

Auto Off Switch

The MC611 incorporates Power Save Circuitry to automatically place the MC611 into the power saving Standby Mode approximately 30 minutes after there has been an absence of an audio input signal.

When there is a Power Control Connection between the MC611 and a Preamplifier with Power Save Circuitry, the AUTO OFF Switch is bypassed (located on the Rear Panel of the MC611). Refer to figure 12.

In the event there is no Power Control Connection and the Power Save Circuitry is activating inappropriately relative to your specific use of the MC611, place the AUTO OFF Switch in the DISable position.

Note: If the Power Save Circuitry has switched Power to the MC611 OFF, place the POWER in the OFF Position and then in the ON position to reset the circuitry.

AUTO
OFF



ENA DIS

Figure 12



Technical Description

McIntosh Laboratory, the company who introduced the world's first amplifier that could be called "High Fidelity", has done it again. The McIntosh engineering staff has created a Power Amplifier without compromise, using the most advanced McIntosh circuit design concepts.

The MC611 has a continuous average power output rating of 600 watts and with a peak output current of 90 amperes; making this one of the most advanced amplifiers available today. The distortion limits for the MC611 are no more than 0.005% at rated power output for all frequencies from 20Hz to 20,000Hz. Typical performance at mid frequencies is less than 0.002%. The true distortion readings on the MC611 are so low, it takes special measuring techniques to make accurate readings. The MC611 can deliver the best possible performance from any type of high quality loudspeaker system. Refer to figure 13.

Creating an amplifier with this level of performance did not come easily. Many months of design, testing and measuring were required. Extensive controlled listening tests, the ultimate form of measuring, were made before the final design was accepted.

Design Philosophy

The design philosophy incorporated in the MC611 involved several different techniques, all based on sound scientific logic. Every stage of voltage or current amplification must be as linear as possible prior to the use of negative feedback. McIntosh engineers know how to properly

design negative feedback circuits so they contribute to the extremely low distortion performance expected from a McIntosh amplifier. The typical McIntosh owner would never accept the approximately 100 times higher distortion of many non-feedback designs.

Double Balanced Push-Pull design is used from input to output. Each half of the amplifier contains complimentary balanced circuitry. The resulting Quad Balanced configuration cancels even order distortion. Refer to figure 16.

All transistors are selected to have nearly constant current gain over the entire current range they must cover. Output transistors in particular, have matched uniform current gain, high current bandwidth product and large active region safe operating area. These Power Transistors are the very latest in semiconductor technology and incorporate a new design known as Thermal-Trak™. Refer to figure 14. This allows for the instantaneous and accurate monitoring of the Power Transistor Temperature.

The MC611 Power Output Circuitry has a specially designed bias circuit to take full advantage of the ThermalTrak™ Power Transistors and thus precisely controls the power amplifier operation over a wide range of music conditions with the benefits of lower distortion and cooler operation. Precision metal film resistors and low dielectric absorption film capacitors are used in all critical circuit locations.

The output signals of the two balanced circuits are coupled together in the unique McIntosh MC611 Output Autoformer. It provides low distortion power transfer at frequencies from below 20Hz to well beyond 20,000Hz with optimum impedance points of two ohms, four ohms and eight ohms. The unequaled



Figure 14

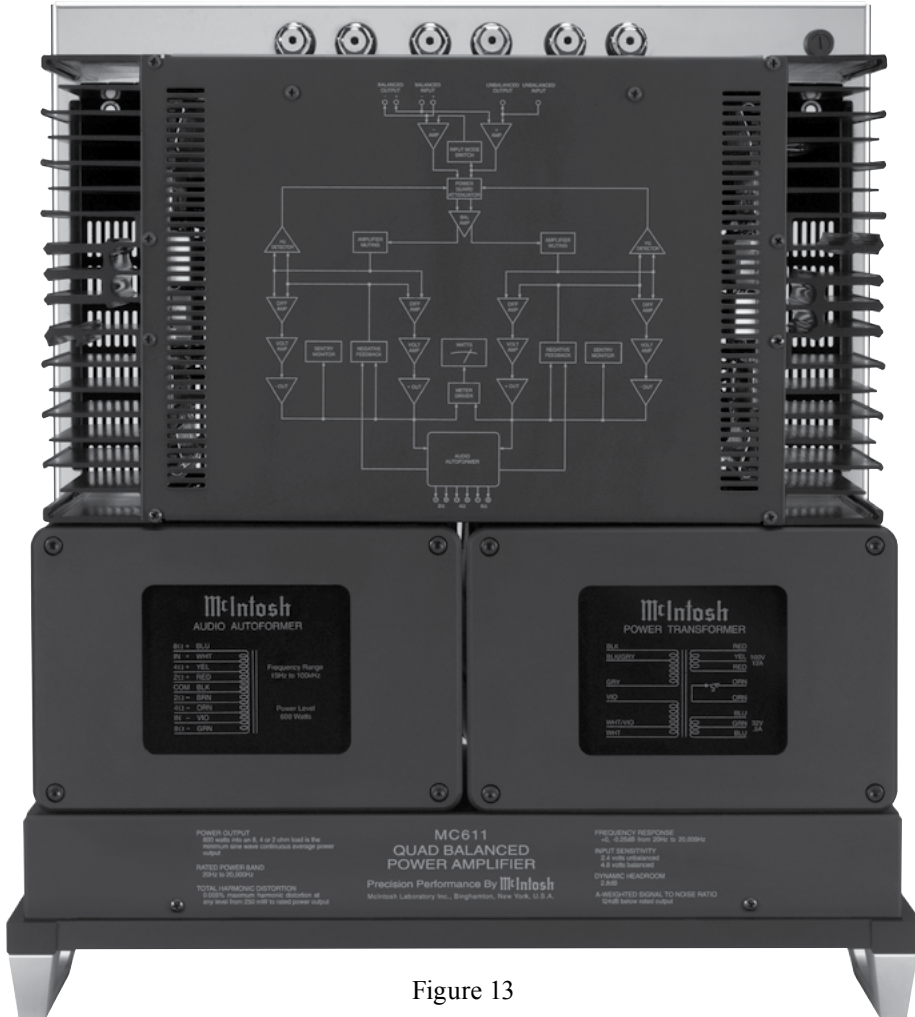

Figure 13

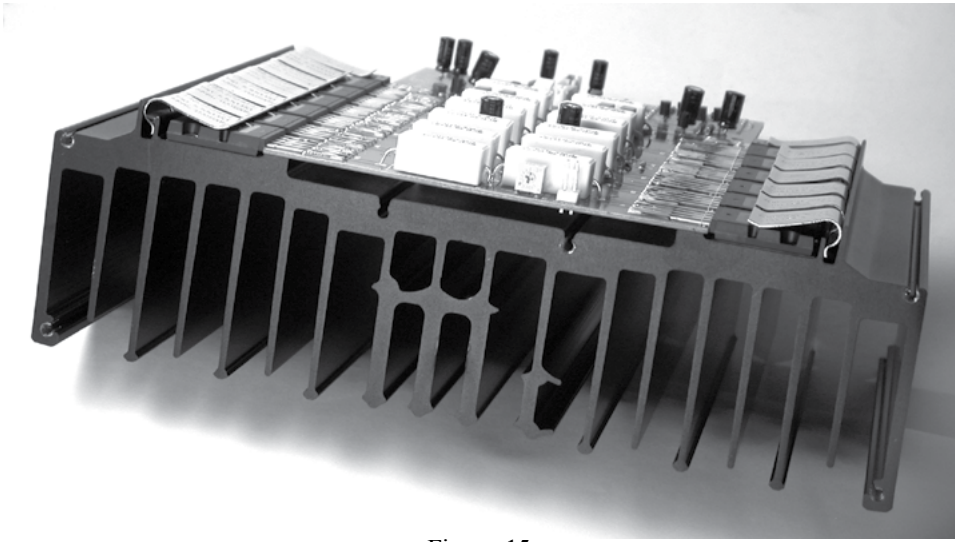

Figure 15

expertise of McIntosh in the design and manufacturing of autoformers is legendary in the high fidelity industry.

The high efficiency circuit design of the MC611 contributes to low operating temperatures. More than 1400 square inches of heat sink area keep the MC611 operating safely with convection cooling. No fans are needed. Refer to figure 15.

Autoformers

All solid state power amplifier output circuits work best

into what is called an optimum load. This optimum load may vary considerably from what a loudspeaker requires. In the case of more than one loudspeaker connected in parallel, the load to the power amplifier may drop to two ohms or even less. A power amplifier connected to a load that is lower than

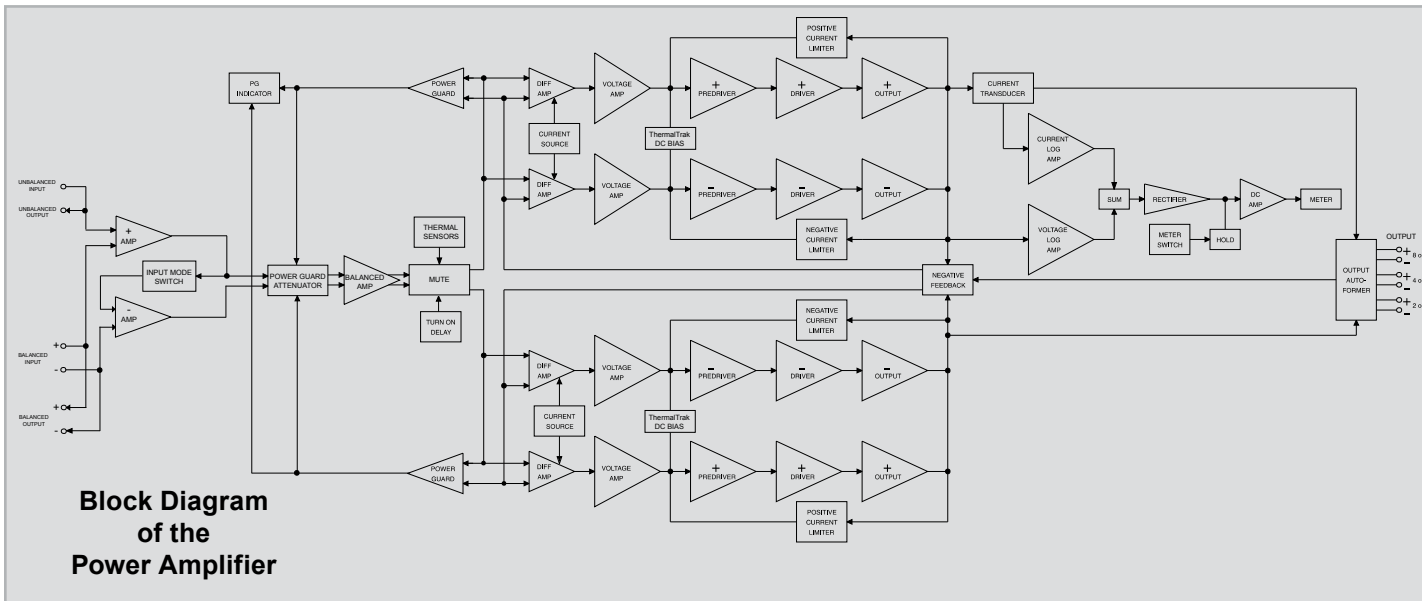

Figure 17

optimum, causes more output current to flow, which results in extra heat being generated in the power output stage. This increase in temperature will result in a reduced life expectancy for the amplifier.

The special Balanced Winding Autoformer creates an ideal match between the power amplifier output stage and the loudspeaker. Refer to figure 17.

There is absolutely no performance limitation with an Autoformer. Its frequency response exceeds that of the output circuit itself, and extends well beyond the audible range. Its distortion level is so low it is virtually impossible to measure.



Block Diagram of the Power Amplifier

Figure 16

Technical Description, con't

In the rare event of a power amplifier output circuit failure, the McIntosh Autoformer provides absolute protection from possible damage to your valuable loudspeakers. The unequaled expertise of McIntosh in the design and manufacturing of Autoformers is legendary in the high fidelity industry. McIntosh engineers know how to do it right.



Figure 18

Power Output Meter

The McIntosh MC611 has a large Output Watt Meter that responds 95% full scale to a single cycle tone burst at 2kHz. Refer to figure 18. Voltage and current outputs are electronically measured, multiplied and fed to a special circuit that accelerates the pointer movement in the upward direction. Refer to figure 26 on the next page. When the pointer reaches its peak it pauses only long enough for the human eye to perceive its position, then drops. It is almost 10 times faster than a professional VU meter.

A front panel switch is provided to change the meter to the Watts Hold Mode of operation. This allows fast upward movement of the pointer but greatly increases Hold Time at the peak of its travel. The highest power output of the source material is thus recorded.

Protection Circuits

The MC611 incorporates the McIntosh Sentry Monitor Output Transistor Protection Circuit. Refer to Figure 19. There is absolutely no compromise in sonic performance with this circuit, and it ensures safe operation of the amplifier under even the most extreme operating conditions. The different types of protection circuits incorporated in the MC611 insure a long and safe operating life. This is just one of the many characteristics of McIntosh Power Amplifiers that make them world famous.

The MC611 also includes the unique patented McIntosh Power Guard circuit. Power Guard eliminates the possibility of ever overdriving the amplifier into clipping. Refer to figures 20, 21 and 22. An overdriven amplifier can produce both audible and inaudible distortion levels exceeding 40%. The audible distortion is unpleasant to hear, but the inaudible ultrasonic distortion is also undesirable, since it can damage valuable loudspeaker system tweeters. You will never experience the harsh

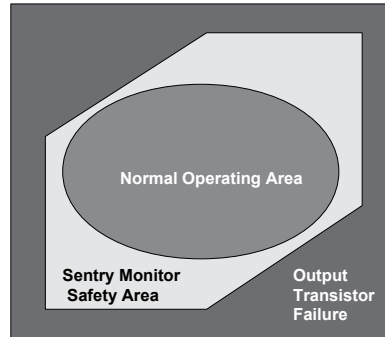

Figure 19

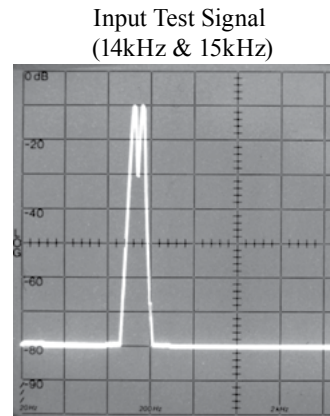

Figure 20

and damaging distortion due to clipping.

The Power Guard circuit is a waveform comparator, monitoring both the input and output waveforms. Under normal operating conditions, there are no differences between the shape of these waveforms. If the amplifier is overdriven, there will be a difference between the two signal waveforms. When the difference exceeds 0.3%, the Power Guard activates the PG light and a dynamic electronic attenuator at the amplifier input reduces the input volume just enough to prevent any further increase in distortion. The Power Guard circuit acts so fast that there are absolutely no audible side effects and the sonic purity of the music reproduction is perfectly preserved. The MC611 Power Amplifier with Power Guard is not limited to just the rated power output, but will actually produce distortion free output well above its rated power due to the McIntosh philosophy of conservative design.

Without Power Guard

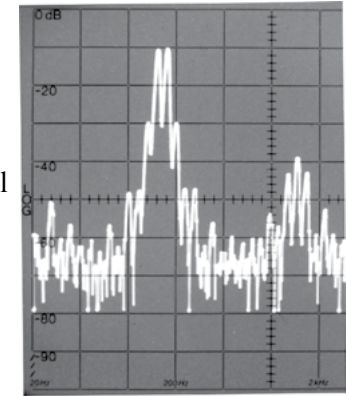

Figure 21

With Power Guard

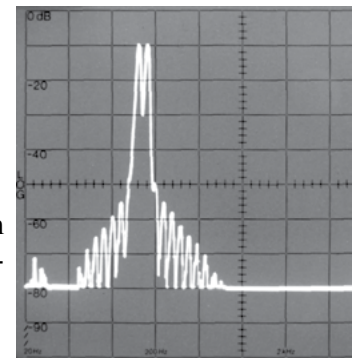

Figure 22

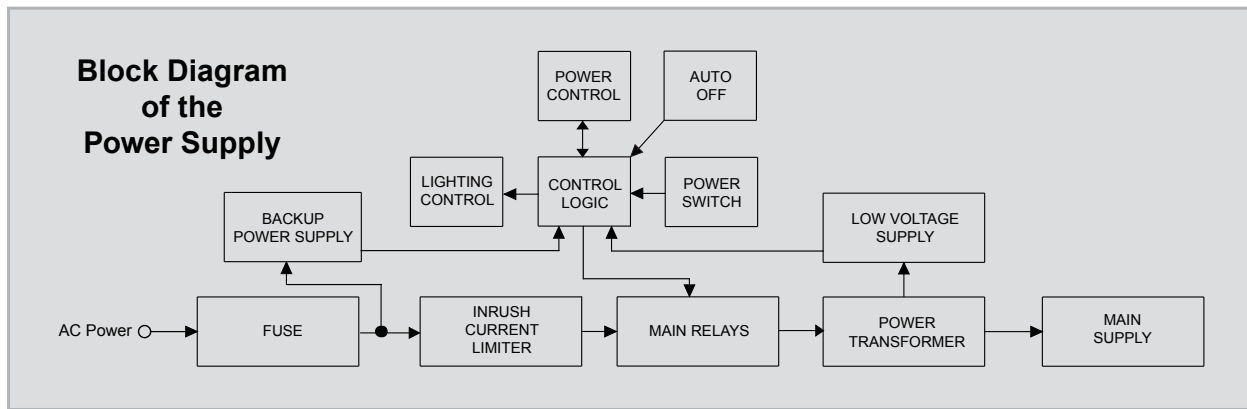

Figure 23

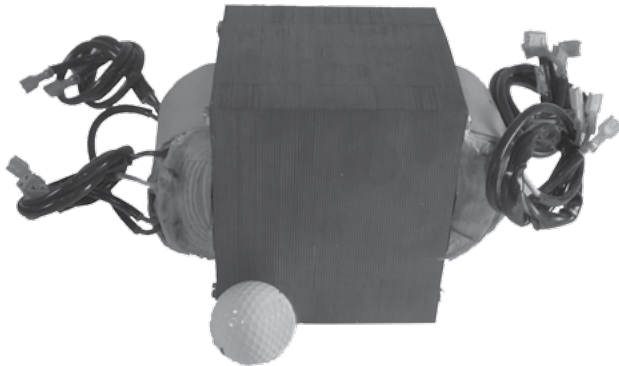

Figure 24

Power Supply Circuits

To compliment the design of the MC611 Power Amplifier Circuitry, there is a high current high voltage power supply. Refer to figures 23 and 26. The very large Power Transformer can supply over 13 amps of current. Refer to figure 24 (golf ball is for size comparison).

It is enclosed in the legendary McIntosh Potted Enclosures and weighs 28 lbs. The four super size main filter capacitors can store over 140 Joules of energy



Figure 25

which is necessary for the wide dynamic range that “Digital Audio” demands. Refer to figure 25.

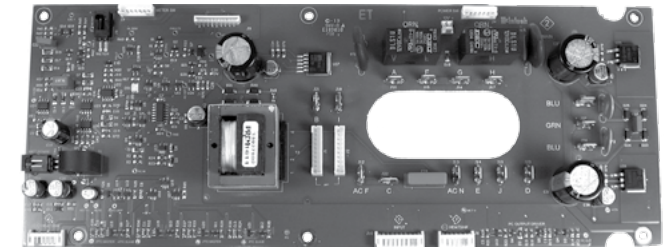

Figure 26

The power amplifier draws high current from the AC power line. Therefore, it is important that they plug directly into the wall outlet.

Also, most owners desire one power switch for the whole audio system. The MC611 is equipped with a circuit that provides remote Power Control from a McIntosh A/V Control Center. Refer to figure 26. When the A/V Control Center is switched On, a (+5V) signal operates the power relay in the MC611. The MC611 also has two remote Power Control Out Jacks. The Power Control signal from these jacks are delayed by a fraction of a second so that the turn on power surge of the next power amplifier occurs at a later time. This helps prevent power circuit overload that could trip circuit breakers or blow fuses, a very important feature in a high power Home Systems employing multiple MC611 Power Amplifiers.



Specifications

Power Output

Minimum sine wave continuous average power output is:

- 600 watts into 2 ohm load
- 600 watts into 4 ohm load
- 600 watts into 8 ohm load

Output Load Impedance

2, 4 or 8 ohms

Rated Power Band

20Hz to 20,000Hz

Total Harmonic Distortion

0.005% maximum harmonic distortion at any power level from 250 milliwatts to rated power, 20Hz to 20,000Hz

Dynamic Headroom

2.8dB

Frequency Response

- +0, -0.25dB from 20Hz to 20,000Hz
- +0, -3.0dB from 10Hz to 100,000Hz

Input Sensitivity (for rated output)

- 4.8 Volts Balanced
- 2.4 Volts Unbalanced

Signal To Noise Ratio (A-Weighted)

- 124dB below rated output, Balanced
- 120dB below rated output, Unbalanced

Intermodulation Distortion

0.005% maximum, if the instantaneous peak power output does not exceed twice the rated power output for any combination of frequencies from 20Hz to 20,000Hz.

Wide Band Damping Factor

Greater than 40

Input Impedance

- 22,000 ohms Balanced
- 22,000 ohms Unbalanced

Voltage Gain

- 29dB, 8 Ohms
- 26dB, 4 Ohms
- 23dB, 2 Ohms

Power Guard

Less than 2% Total Harmonic Distortion with up to a 14dB overdrive signal

Power Control Input

5-15VDC, less than 1mA

Power Control Output 1 and 2

- 12VDC, 50mA maximum total
- Output is delayed 0.2 seconds from turn On

Power Requirements

Field AC Voltage conversion of the MC611 is not possible. The MC611 is factory configured for one of the following AC Voltages:

- 100V ~ 50/60Hz at 8 Amps
- 110V ~ 50/60Hz at 6.6 Amps
- 120V ~ 50/60Hz at 6.6 Amps
- 127V ~ 50/60Hz at 6.6 Amps
- 220V ~ 50/60Hz at 3.6 Amps
- 230V ~ 50/60Hz at 3.3 Amps
- 240V ~ 50/60Hz at 3.3 Amps
- Standby: less than 0.5 watt

Note: Refer to the rear panel of the MC611 for the correct voltage.

Overall Dimensions

- Width is 17-1/2 inches (44.45cm)
- Height is 9-7/16 inches (23.97cm) including feet
- Depth is 22 inches (55.88cm) including the Front Panel, Handles and Cables

Weight

97.5 pounds (44.32 kg) net, 130.5 pounds (59.32 kg) in shipping carton

Shipping Carton Dimensions

- Width is 29-1/2 inches (74.93cm)
- Height is 17 inches (43.18cm)
- Depth is 29 inches (73.66cm)

Packing Instructions

In the event it is necessary to repack the equipment for shipment, the equipment must be packed exactly as shown below. It is very important that the four plastic feet are attached to the bottom of the equipment. Four 1/4 - 20x2-1/4 inch screws and washers must be used to fasten the unit securely to the bottom pad and wood skid. This will ensure the proper equipment location on the bottom pad. Failure to do this will result in shipping damage.

Use the original shipping carton and interior parts only if they are all in good serviceable condition. If a shipping carton or any of the interior part(s) are needed, please call or write Customer Service Department of McIntosh Laboratory. Refer to page 2. Please see the Part List for the correct part numbers.

Quantity	Part Number	Description
1	034052	Shipping carton top
1	034051	Shipping carton bottom
2	034054	Foam Pad (top and bottom)
2	034186	Foam Pad (front and rear)
2	034187	Foam Pad (sides)
1	034136	Inner carton top
1	034137	Inner carton bottom
1	034188	Foam Pad (inner carton)
1	034479	Shipping skid
4	401212	1/4 - 20x2-1/4 cap screw
4	104058	Flat washer

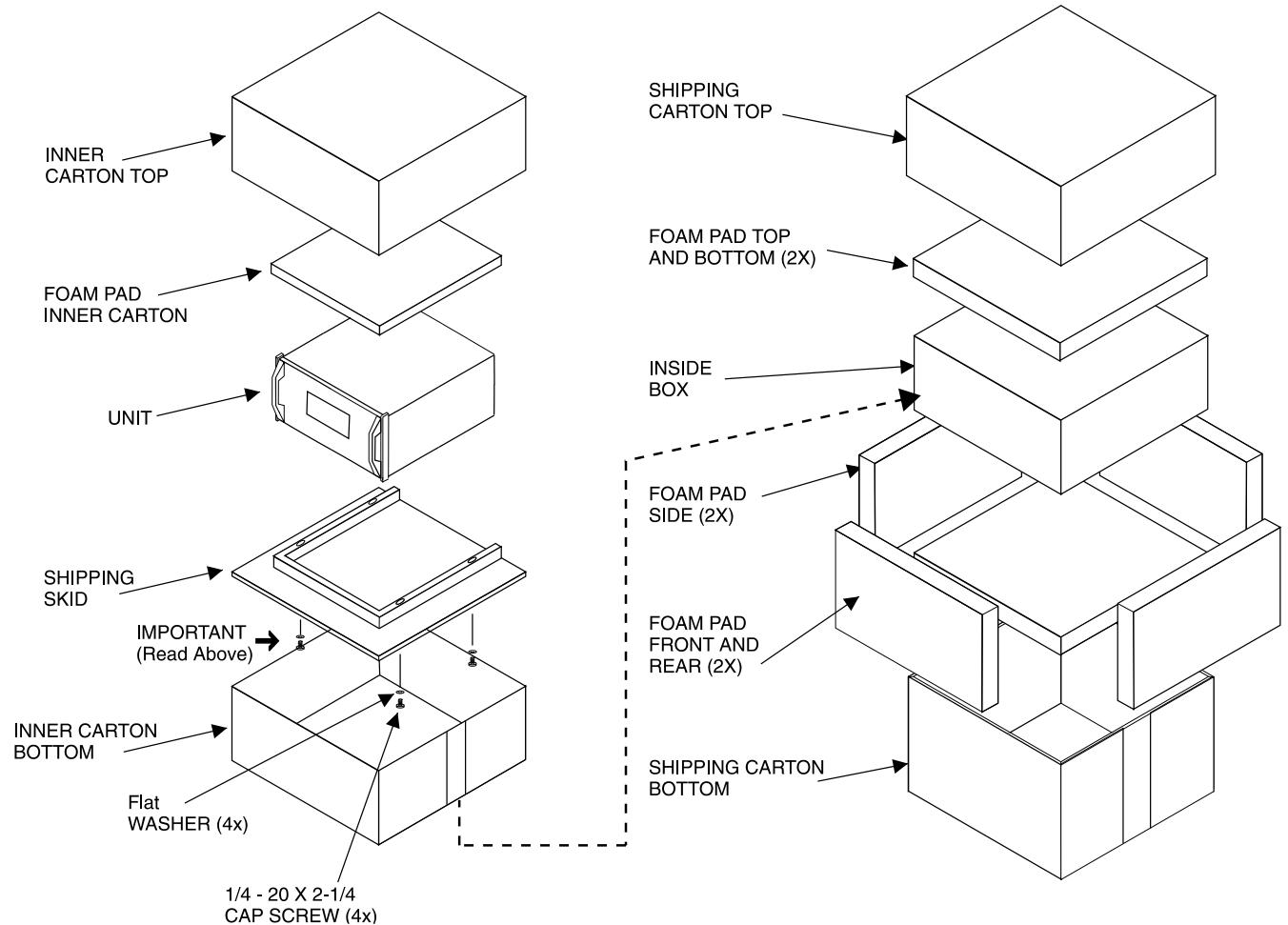



McIntosh Laboratory, Inc.
2 Chambers Street
Binghamton, NY 13903
www.mcintoshlabs.com

The continuous improvement of its products is the policy of McIntosh Laboratory Incorporated who reserve the right to improve design without notice.
Printed in the U.S.A.